



**COMPONENTS**

- Material: Food approved high density polyethylene
- Standard Color: White (Other colors on request)
- Plastic Fingergrasp Handle
- Pour spouts available
- Gasket: EPDM (Ethylene Propylene Diene Monomer)

**WALL THICKNESS**

	cm	inch
• Pail	.180	.071
• Gasket Lid (656)	.203	.080
• Snap On Lid (642)	.170	.067

**STANDARD WEIGHT (+/- 2%)**

	g	lb.
• Pail (with handle)	830	1.83
• Gasket Lid (656) (including gasket)	282	0.62
• Snap On Lid (642)	182	0.40

**THERMAL RESISTANCE** (Tested with water)

- Filling from -38°C (-36°F) to 82°C (180°F)
- Warehousing from -40°C (-40°F) to 39°C (102°F)

**TOP LOADING RESISTANCE**

	kg	lb.
• With Gasket Lid (656)	200	440
• With Snap On Lid (642)	140	308

**CAPACITIES**

VOLUME	Litres	GALLONS	
		Imp.	U.S.
Nominal	20.00	4.40	5.28
Maximum to Overflow	22.37	4.92	5.91
Maximum with Gasket Lid	21.12	4.65	5.58
Maximum with Snap On Lid	21.47	4.72	5.67

PRODUCT DENSITY g/cm <sup>3</sup>	Maximum Weight Filled with Lid			
	GASKET LID		SNAP ON LID	
	kg	lb	kg	lb
0.5	11.12	24.46	11.24	24.73
0.6	13.34	29.35	13.49	29.68
0.7	15.56	34.24	15.74	34.62
0.8	17.79	39.13	17.99	39.57
0.9	20.01	44.02	20.23	44.51
1.0	22.23	48.91	22.48	49.46
1.1	24.46	53.80	24.73	54.41
1.2	26.68	58.69	26.98	59.35
1.3	28.90	63.58	29.23	64.30
1.4	31.12	68.47	31.47	69.24
1.5	33.35	73.37	33.72	74.19

Above is a guideline only.  
Customer should verify with specific product to be packaged.

**20 LITRE LIGHTWEIGHT CONTAINER**

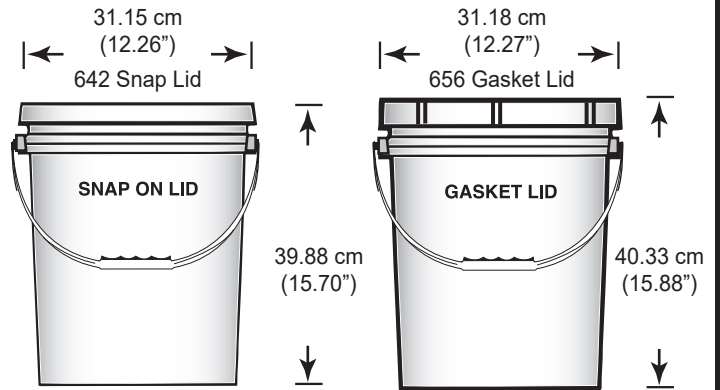

**NESTING**

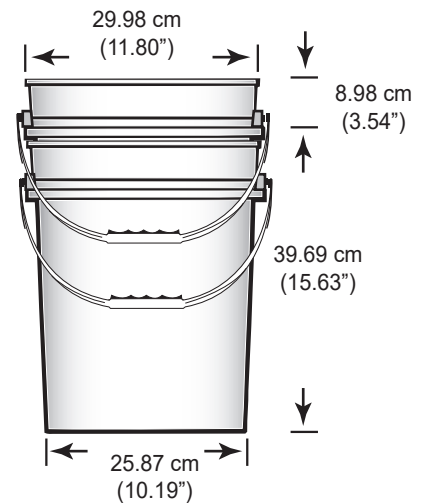

**STACKING**

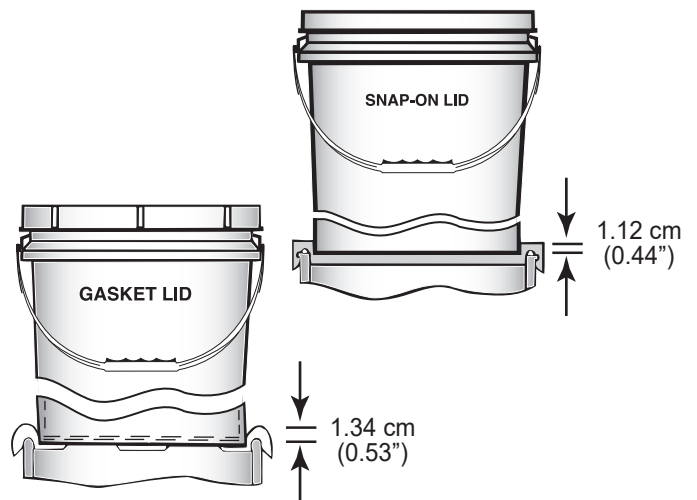

**PALLET UTILIZATION**

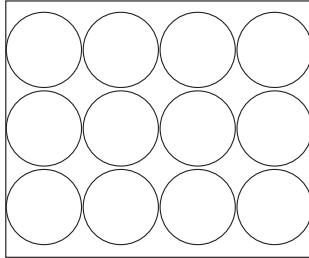

122 cm x 102 cm  
(48" x 40")

**IMPORTANT:** Never let pails overlap edge of pallet

**RECOMMENDED STACKING HEIGHT**

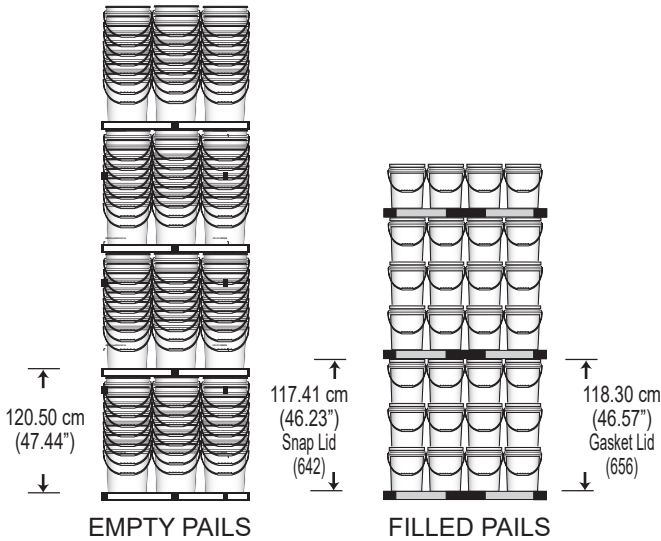

**OPENING**

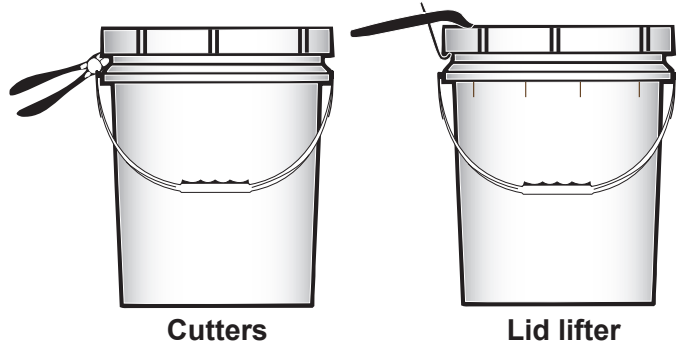

**CLOSING**

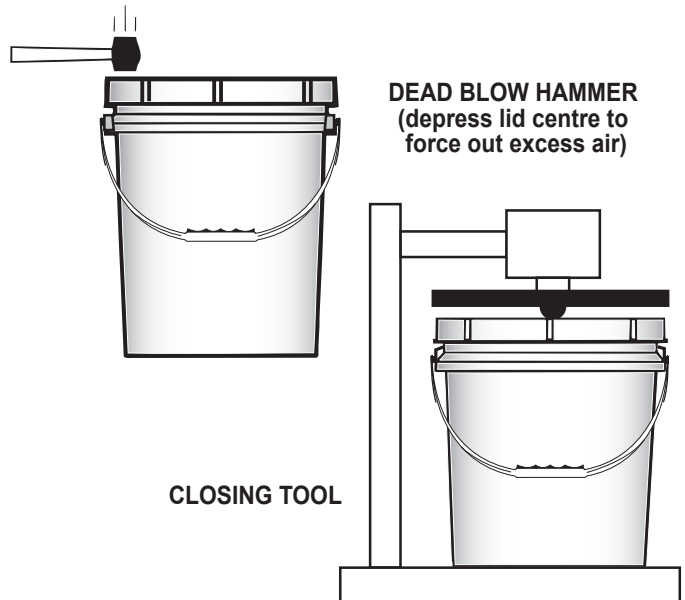

**PRINTING**

DRY OFFSET PRINTING (UP TO MAXIMUM 4 PANTONE COLORS)

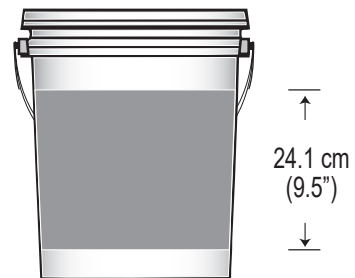

**SHIPPING DATA**

Quantity	745 PAIL	SNAP LID 642		GASKET LID 656	
	120/pallet	60/box	600/plt	40/box	240/plt
Dimensions*	49.75" x 37.75" x 47.75"	25.75" x 13.00" x 22.50"	49.75" x 37.75" x 36.00"	25.75" x 13.00" x 20.25"	49.75" x 37.75" x 18.00"
Volume	51.90 cu. ft.	4.36 cu. ft.	39.13 cu. ft.	3.92 cu. ft.	19.56 cu. ft.
Weight**	81.18 kg 178.60 lbs	11.92 kg 26.22 lbs	110.70 kg 243.54 lbs	12.13 kg 26.69 lbs	69.18 kg 152.20 lbs

\* AND \*\* DOES NOT INCLUDE WOODEN PALLET  
\*\*\* BASED ON GASKET LID WITHOUT FITTINGS

**APPROVALS**

Pro-Western Plastics Ltd. disclaims any liability for the use of the information and data contained herein. We reserve the right to alter or modify any product and/or specification, at any time.